

# AC-2200 USER GUIDE

---

Version Eng-1.11



## &lt;Revision History&gt;

Version	Date	Description	Firmware Version
1.00	2015-09-01	- Initial Release	10.61.00-000.00
1.01	2015-10-18	- Form Change	10.61.00-000.02
1.02	2015-12-28	- Modify Display	10.61.00-000.09
1.03	2015-01-18	- Error Correction - Add Default Setting - Add LFD Setting - Add UDL Setting	1x.61.00-000.12 (Version Change)
1.04	2016-01-26	- Modify SN-related Information	1x.61.00-000.14
1.05	2016-01-29	- Modify Misspelling	1x.61.00-000.15
1.06	2016-02-05	- Modify Misspelling	1x.61.00-000.16
1.07	2016-03-07	- Add a reboot phrase after setting	1x.61.00-000.20
1.08	2016-03-18	- Complete a Korean version of manual	1x.61.00-000.22
1.09	2016-05-02	- Error Correction	1x.61.00-000.25
1.10	2016-06-27	- Door Icon Description Change	1x.61.00-000.29
1.11	2017-06-21	- DDNS Port Default fix	1x.61.00-000.37

## <Glossaries>

- Administrator (Admin)
  - The administrator can access to the terminal menu mode. He/she has the authority to add/modify/delete terminal users and to change the operating environment by changing settings.
  - If there is no registered administrator in the terminal, anybody can access to the terminal menu and change settings. **It is recommended that more than one administrator will be necessarily registered in the terminal.**
  - The administrator has the authority to change critical environmental settings of the fingerprint reader. So, special attention is required to its registration and operation.
- 1:1 Authentication (One-to-one, Verification)
  - The user fingerprint is verified after entering User ID or Card.
  - Only User ID or the user fingerprint registered to the card is compared. This is called One-to-One Authentication.
- 1:N Authentication (One-to-many, Identification)
  - The user is identified only by the fingerprint.
  - The same fingerprint as the input fingerprint is identified among the registered fingerprints without User ID or Card entered. This is called One-to-N Identification.
- Authentication Level
  - As a level used for fingerprint authentication, it is displayed in Step 1 to 9. Authentication cannot be allowed before the degree of match between two fingerprints is higher than the set authorization level.
  - The higher authentication level may ensure the higher security. But it requires the relatively high concordance rate. So it high likely to deny authentication when trying to authenticate.
  - 1:1 Level: Authentication level used for One-to-one authentication
  - 1:N Level: Authentication level used for One-to-N authentication
- Authentication Method
  - This refers to various types of authentication methods composed of each combination of FP(Fingerprint) and RF(Card) and so forth.  
Ex) Card or FP: Authenticated by either card or fingerprint
- Function Key
  - This refers to [F1], [F2], [F3], and [F4] keys, which enable users to access the menu or change the mode such as Attend or Leave.

## Table of Contents



<Revision History>.....	2
<Glossaries> .....	3
Table of Contents .....	4
<b>1. Before Getting Started .....</b>	<b>6</b>
<b>1.1. Safety Notes.....</b>	<b>6</b>
<b>1.2. Product Details .....</b>	<b>7</b>
<b>1.3. Buttons displayed during operation .....</b>	<b>8</b>
<b>1.4. ViRDI logo LED signals displayed during operation .....</b>	<b>8</b>
<b>1.5. Screens displayed during operation.....</b>	<b>8</b>
1.5.1. Icon Information.....	9
1.5.2. Message Information.....	9
<b>1.6. Voice guide announced during operation.....</b>	<b>13</b>
<b>1.7. Buzzer guide announced during operation .....</b>	<b>13</b>
<b>1.8. How to register and enter correct fingerprint .....</b>	<b>13</b>
<b>2. Product Description .....</b>	<b>15</b>
<b>2.1. Product Features .....</b>	<b>15</b>
<b>2.2. Configuration Diagram .....</b>	<b>17</b>
2.2.1. Standalone Use (Access).....	17
2.2.2. Connecting the PC server (Access, T&A, Food Service Control).....	17
<b>2.3. Product Specification .....</b>	<b>18</b>
<b>3. Environment Setting.....</b>	<b>19</b>
<b>3.1. Checkpoints before environment setting.....</b>	<b>19</b>
3.1.1. Enter the menu .....	19
3.1.2. Modify settings.....	20
3.1.3. Save after completion of environment setting.....	20
<b>3.2. Menu Configuration.....</b>	<b>21</b>
<b>3.3. User Management .....</b>	<b>24</b>
3.3.1. Add User.....	24
3.3.2. Delete User.....	27
3.3.3. Modify User .....	28
3.3.4. Add Administrator .....	31
3.3.5. Delete All Users .....	31
<b>3.4. Network Setting .....</b>	<b>32</b>
3.4.1. Terminal ID .....	32
3.4.2. IP Setting .....	34
3.4.3. Server IP Setting.....	35
<b>3.5. Option Setting.....</b>	<b>39</b>
3.5.1. Application Setting.....	39

3.5.2. Authentication Method Setting.....	43
3.5.3. Door Setting .....	47
3.5.4. Volume Setting .....	48
3.5.5. Camera Setting .....	49
3.5.6. Current Time Setting .....	50
3.5.7. RS485 Set.....	51
3.5.8. Mobile Key Setting .....	52
<b>3.6. Terminal Information Inquiry .....</b>	<b>53</b>
<b>3.7. Additional Function .....</b>	<b>54</b>
3.7.1. Terminal Lock Setting .....	54
3.7.2. Card Number Inquiry .....	55
3.7.3. Monitor Input Port Setting .....	55
3.7.4. Duress FP Setting .....	57
<b>3.8. Device Setting.....</b>	<b>58</b>
3.8.1. System Configuration.....	58
3.8.2. Card Reader Format Setting.....	59
3.8.3. Fingerprint Sensor Setting.....	59
3.8.4. Wiegand Speaker Output.....	61
3.8.5. Terminal Initialization .....	63
3.8.6. External Device Setting.....	65
<b>4. How to Use Terminal .....</b>	<b>68</b>
<b>4.1. When operating to [1.Access].....</b>	<b>68</b>
4.1.1. Authentication Mode .....	68
4.1.2. Authentication Using Fingerprint.....	68
4.1.3. Authentication Using Card .....	69
<b>4.2. When operating to [2.T&amp;A] .....</b>	<b>71</b>
4.2.1. Authentication Mode .....	71
4.2.2. Fingerprint Authentication .....	71
4.2.3. Authentication Using Card.....	71
<b>4.3. When operating to [2.Cafeteria] .....</b>	<b>71</b>

# 1. Before Getting Started



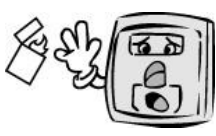



## 1.1. Safety Notes

### ● Warning

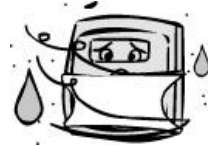
<p>Do not operate the terminal with wet hands, and pay attention not to let any liquid such as water enter inside the terminal. → Otherwise, malfunction or electric shock may be caused.</p>		<p>Keep the terminal away from inflammables. → Otherwise, it may cause a fire.</p>	
<p>Do not disassemble, repair or remodel the terminal at your disposal. → Otherwise, it may cause malfunction, electric shock, or a fire.</p>		<p>Do not allow children to touch the terminal carelessly. → Otherwise, it may cause safety accidents of children or malfunction.</p>	

- Non-compliance of safety notes may cause death or serious injury for users.

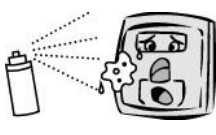
### ● Cautions

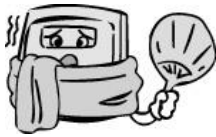
<p>Do not install the terminal in a place exposed to direct sunlight. → Otherwise, it may cause malfunction, deformation and discoloration.</p>		<p>Do not install the terminal in humid or dusty places. → Otherwise, it may cause malfunction.</p>	
<p>Do not clean this terminal by sprinkling water, nor wipe it with benzene, thinner, and alcohol. → Otherwise, it may cause electric shock or a fire.</p>		<p>Keep the terminal away from magnets. → Otherwise, it may cause failure and malfunction.</p>	
<p>Keep the fingerprint input section clean. → Otherwise, the fingerprint cannot be recognized correctly.</p>		<p>Do not spray insecticides or inflammables on the terminal. → Otherwise, it may cause deformation and discoloration.</p>	
<p>Keep the terminal away from shock or sharp objects. → Otherwise, it may damage the terminal and result in malfunction.</p>		<p>Do not install the terminal in a place where there is a severe change in temperature. → Otherwise, it may cause malfunction.</p>	

- Non-compliance of safety notes may cause personal injury or property damage for users.

※ We are not responsible for any accidents and damage that may arise from non-compliance of the information in this manual.

## 1.2. Product Details



## 1.3. Buttons displayed during operation

F1	<ul style="list-style-type: none"> <li>- Switch to 'Attend' mode from the default screen.</li> <li>- Used to move up or increase [↑] in the menu mode</li> </ul>
F2	<ul style="list-style-type: none"> <li>- Switch to 'Leave' mode from the default screen.</li> <li>- Used to move down or decrease [↓] in the menu mode.</li> </ul>
F3	<ul style="list-style-type: none"> <li>- Switch to 'Outdoor' mode from the default screen.</li> <li>- When pressing for more than 2 seconds, you enter the menu mode: [F3~]</li> <li>- Used to escape [ESC] or move left [←] in the menu mode. When pressing for more than two seconds, this is used to [ESC] button: [ESC~]</li> </ul>
F4	<ul style="list-style-type: none"> <li>- Switch to 'Return' mode from the default screen. Pressing it again in the 'Return' mode is changed to 'Access' mode.</li> <li>- Used to enter [ENT] or move right [→] in the menu mode. When pressing for more than two seconds, this is used to [ENT] button: [F4~]</li> </ul>

## 1.4. ViRDI logo LED signals displayed during operation

<i>ViRDI</i>	Power	Blue	On: Normal Flickering: Under Bluetooth communication
<i>ViRDI</i>	Door	Green	On: Door Open Off: Door Close
<i>ViRDI</i>	Alarm	Red	Off: Normal Flickering: Case Open or Lock Controller Communication Error

※ The LED may light on simultaneously in some cases. (Ex. Red and Blue flicker)

## 1.5. Screens displayed during operation

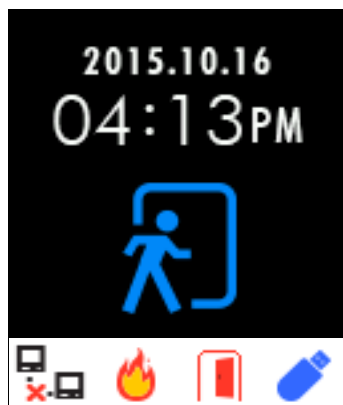

← Displays the current time

- When access control: Displays access mode (F1, F2, F3, F4, Access)





- When T&A control: Displays Attend/Leave mode (Attend, Leave, Outdoor, Return)

- When food service control: Displays the menu and current meal time countdown



← Displays Status icon and Access mode



## 1.5.1. Icon Information

① Fire Detection		A fire is detected by the fire detection sensor.
② Door Status		Doors open state (forced open door or open the door when leaving).
③ Server Connection Status		The LAN cable is not connected.
		Only Link is connected.
④ USB Connection		The USB is connected.

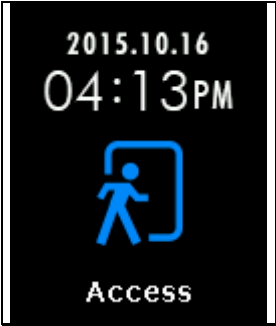
## 1.5.2. Message Information

	- The default screen of AC2200
	- The fingerprint is being input or on standby.
	- When authentication is successful



- When authentication fails

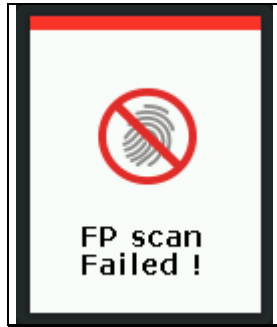

- When fingerprint input fails
- If your finger is released too early before your fingerprint is entered

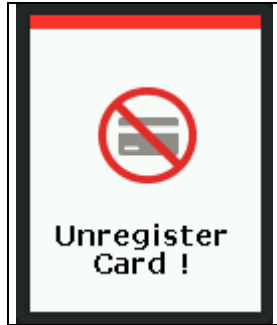



- When an unregistered card is swiped
- When 1:N Authentication is attempted under the condition that authentication priority is SN and there is no user who has been allowed for 1:N Authentication

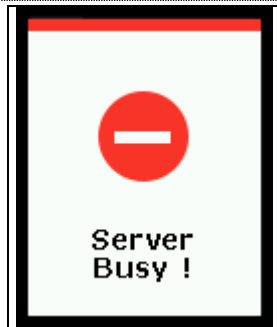

- When anti-passback is in error

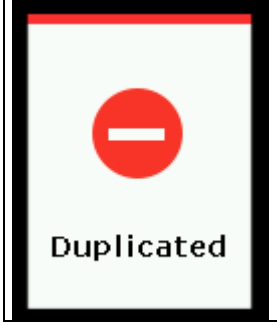
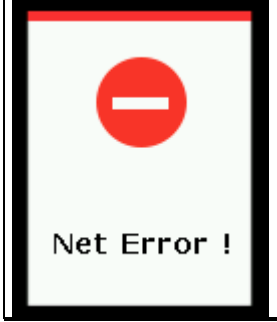

- When the server cannot handle too many authentication requests from the terminal

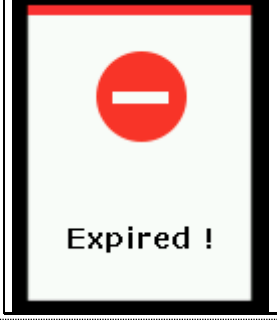
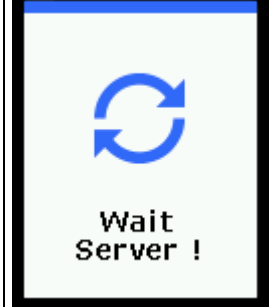
 A screen with a red circle containing a white horizontal bar, and the word "Duplicated" below it.	<ul style="list-style-type: none"><li>- When the terminal is set to the food service control and users attempt more than two times authentication in the same food time zone</li></ul>
 A screen with a red circle containing a white horizontal bar, and the text "Net Error !" below it.	<ul style="list-style-type: none"><li>- When there is no response from the server during authentication attempt</li><li>- When the network is disconnected during authentication attempt to the server</li></ul>
 A screen with a blue icon of a person and a card, and the text "Add Card" above and "Place Your Card" below it.	<ul style="list-style-type: none"><li>- The card input is on standby.</li></ul>
 A screen with a red circle containing a white horizontal bar, and the text "Expired !" below it.	<ul style="list-style-type: none"><li>- When the card is registered but its authentication is not attempted in the access control time</li></ul>
 A screen with a blue circular arrow icon, and the text "Wait Server !" below it.	<ul style="list-style-type: none"><li>- When the terminal waits for a response after requesting authentication to the server,</li></ul>

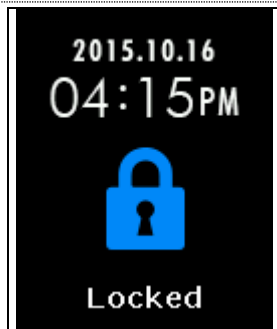

- When the terminal is locked
- When the food service control is set in the non-meal time



- When the terminal program is upgraded  
(Do not power off the terminal when this message is displayed.)

## 1.6. Voice guide announced during operation

Item	Voice Guide
When the fingerprint is entered	Please enter your fingerprint.
When authentication is successful	You are authorized.
When authentication fails	Please try again.

## 1.7. Buzzer guide announced during operation

Ppik	When button or card is operated	- If the button is pressed or if the terminal reads the card - If your finger may be released because your fingerprint has been successfully entered
Ppibik	When failure	If authentication fails or the user's input is wrong
Ppiririk	When input standby	When it is notified that fingerprint input is on standby
Ppiririk	When success	If authentication is successful or if the current user finishes settings

## 1.8. How to register and enter correct fingerprint

- Correct fingerprint input method

Enter your fingerprint as if you take a thumbprint by using your forefinger if possible. The fingerprint cannot be correctly registered and entered only by your fingertips. The center of the fingerprint should be touched with the fingerprint input section.

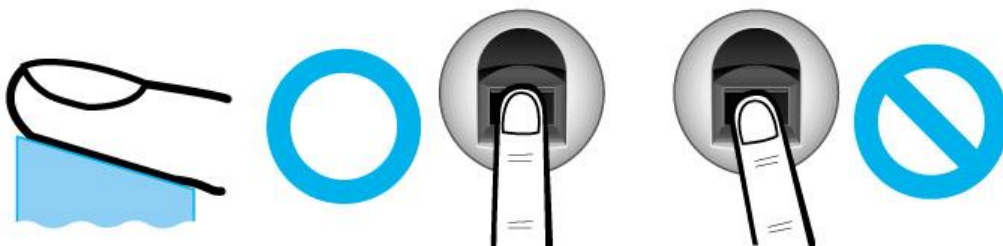

- Enter the fingerprint of your forefinger if possible.

When using your forefinger, you can enter your fingerprint correctly and safely.

- Make sure that the fingerprint is unclear or wounded.

Too dry, wet, blurry or wounded fingerprints are difficult to recognize. In this case, the fingerprint of another finger should be registered.



- Precautions subject to your fingerprint status

The availability of the fingerprint may vary subject to your fingerprint status.

- This product consists of a fingerprint recognition system and cannot recognize the damaged or unclear fingerprints. They should be registered using a password.
- **If your hands are dry, you can blow your breath on the system** to operate it more smoothly.
- For children, too small or unclear fingerprints may be difficult or impossible to use. They need to register a new fingerprint every six months.
- For seniors, the fingerprint with too many lines may not be registered.
- It is recommended that you will register more than two fingerprints if possible.
- In order to increase the fingerprint authentication rate, it is recommended to use six of the ten fingers as illustrated above. (Both thumbs, forefingers, middle fingers)

## 2. Product Description

### 2.1. Product Features

- **Access control system using the network (LAN)**
  - The fingerprint reader communicates with the authentication server using a UTP cable and TCP/IP protocol. This terminal can be applied to the existing LAN network and has easy expandability. It ensures a fast speed by **10/100 Mbps Auto Detect** and facilitates management and monitoring via the network.
- **Convenient Auto Sensing function**
  - The authentication function can be simply operated by entering the fingerprint without separate keys entered.
- **Easy to verify your ID via fingerprint**
  - The use of the fingerprint recognition technology (Biometrics) can prevent forgetting your password, losing your card or key, or avoid the risk of their theft. The use of personal fingerprints enhances the security of authentication.
- **Convenient information message using LCD and voice**
  - The information message is voiced or displayed on the LCD display for each operation to receive certification so that you can easily input. In particular, thanks to a built-in backlight for the LCD display, you can easily identify the screen and operate keys in the dark room. The voice is stored in the memory and it can be changed to a desired voice from the server.
- **Diverse and flexible access control function**
  - Easy to use it without the risk of rental, counterfeit and loss of your key or card;
  - Provide the complete access control function by granting access authority according to user groups;
  - Provide the flexibility of access control by allowing the access time restrictedly;
  - Economical maintenance and development costs compared to other access control devices;
  - Remove the inconvenience that visitors are registered in the management office and then separate cards are issued.
- **Diverse utilization for operating systems such as security, access, T&A, and food service**
  - Various operating methods can be supported depending on how the terminal menu is set.
- **Large processing capacity of server**
  - When the entrant information is managed using the server, it can be processed almost infinitely.
- **Mobile interlocking function**
  - By using mobile Bluetooth, the terminal can be set to Admin App (UNIS-B Plus).
  - By using mobile Bluetooth, the user can be authenticated to User App (imkey).

- **Various registration and authentication methods**

There are a total of four registration and authentication methods for general users. Before registering users or administrators, you should determine how to register and authenticate.

FP	Fingerprint Registration Fingerprint Authentication
Card	Card Registration Card Authentication
M.Key	Mobile Key Registration Mobile Key Authentication
Card or FP	Card or Fingerprint Registration Card or Fingerprint Registration
Card and FP	Card and Fingerprint Registration Card Authentication and then Fingerprint Authentication
M.Key and FP	Mobile Key and Fingerprint Registration Mobile Key Authentication and then Fingerprint Authentication



2.2. Configuration Diagram

2.2.1. Standalone Use (Access)

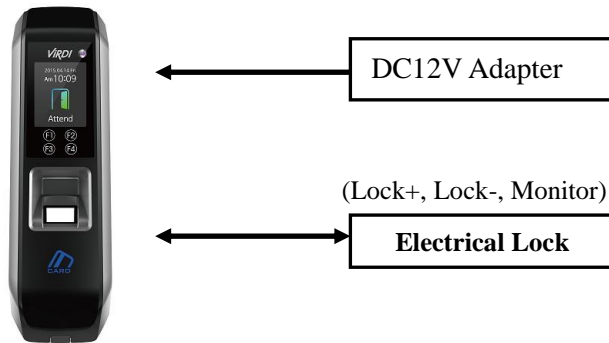

2.2.2. Connecting the PC server (Access, T&A, Food Service Control)

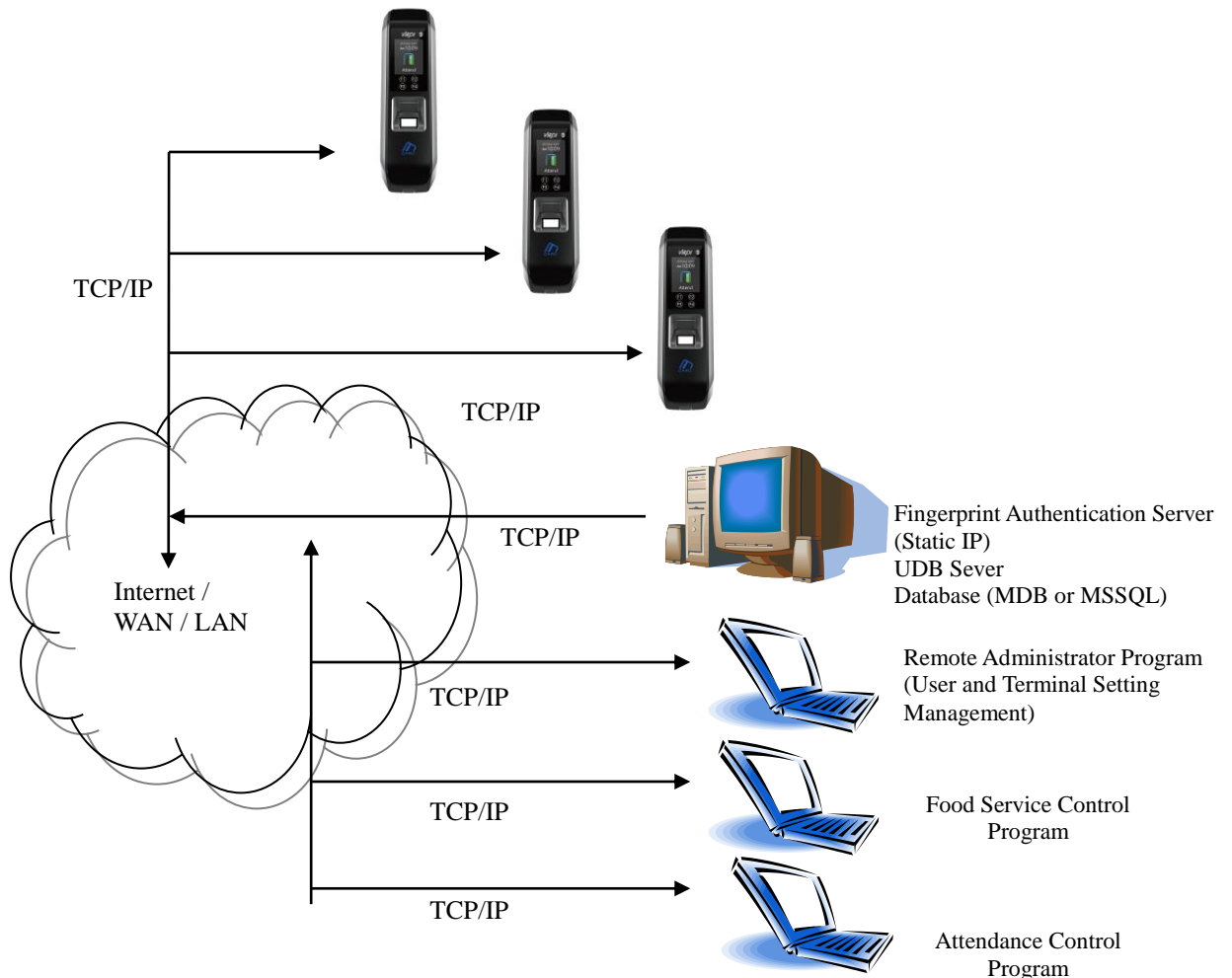

## 2.3. Product Specification

ITEM	SPEC	REMARKS
CPU	32Bit RISC CPU(400MHz)	
MEMORY	128M SDRAM	
	32M NOR FLASH 128M NAND FLASH	5,000/1000 User 5,000/1000 Finger 100,000 Log 10,000 Picture
Fingerprint Sensor	Optical	
Authentication Speed	Less than 1 second	
Scan Area / Resolution	14.8 * 17.9mm / 500 DPI	
FRR / FAR	0.1% / 0.0001%	
Communication Port	TCP/IP	Authentication Server Communication
	Bluetooth	Mobile Interlocking
	RS-485	External Device Communication
	Wiegand In/Out	Card Reader or External Device Communication
Temperature / Humidity	-20 ~ 60 / Lower than 90% RH	
LCD	1.77" Color LCD	
SIZE	58mm(W) * 191mm(H) * 62mm(D)	
AC / DC Adapter	INPUT : Universal AC 100 ~ 250V	
	OUTPUT : DC 12V (Option : DC 24V)	
	UL, CSA, CE Approved	
Card Reader	Smart Card Reader	14443A type, 13.56MHz

## 3. Environment Setting

### 3.1. Checkpoints before environment setting

#### 3.1.1. Enter the menu

When pressing [F3] button for more than 2 seconds, the administrator authentication screen will be displayed.



The administrator is verified by either card or fingerprint depending on the authentication method. Upon successful authentication, the screen goes to the following menu.

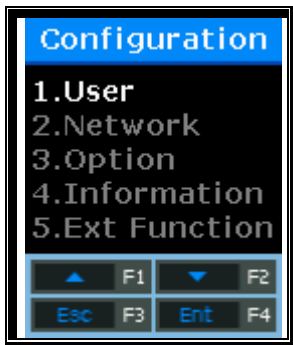

Select the menu you want to change using [↑](F1) and [↓](F2) buttons, and press [ENT] (F4) button to go to the submenu.

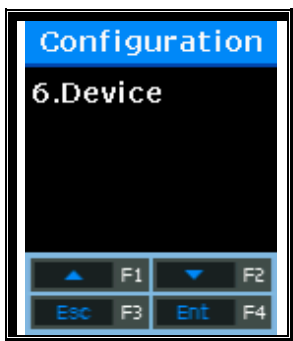

The description of function buttons such as F1, F2, F3, and F4 is in numerical order on the bottom of the screen as shown above. Go up and down the screen, you can press [ENT](F4) button to select the desired menu, or press [ESC] (F3) for more than 2 seconds to return to the upper menu.

- ※ **The administrator authentication menu is displayed only when there is any registered administrator.** Once it is authenticated to enter the menu mode, you can access to all menus until you escape completely from the main menu.

### 3.1.2. Modify settings

Modify the existing settings by pressing [↑][↓] buttons.

If the set value is greater than or equal to 2 digits, press [←][→] buttons to move to the digit you want to change, and press [↑][↓] buttons to change the value up or down.

Press [ENT] button to check the set value or go to next setting.

If you want to cancel during the setting and move to the upper menu, press [ESC] button for more than 2 seconds.

If only [←][↑][↓][→] buttons are displayed except [ESC] and [ENT] buttons, [ESC] is enabled by pressing [F3] for more than 2 seconds, and [ENT] by pressing [F4] for more than 2 seconds.

### 3.1.3. Save after completion of environment setting

After changing settings, press [ESC] button on the main menu screen to save the changes, and the following screen will be displayed.



Select [Yes] button to save modifications, [No] button to cancel modifications, and then press [ENT] button. If there is any modified information, the terminal will be rebooted.

- If there is no change information, the screen exits from the environment setting menu without the “Save?” process.
- If no data is input in the main menu for a certain time during changing environment setting, the screen will exit from the environment setting menu. In this case, if there is any change in the menu, the screen performs the “Save?” process. If there is no change in the menu, the screen goes to the main screen without saving changes.

## 3.2. Menu Configuration

1. User	1. Add User 2. Delete 3. Modify 4. Add admin 5. Delete All	
2. Network	1. Terminal ID	<Terminal ID> <Auth Mode>:NS/SN/NO/SO
	2. Terminal Net	<Net Type> <Terminal IP> <Subnet Mask> <Gateway>
	3. Server Net	<Server Type> <Server IP> <Server Port>
3. Option	1. Application	<WorkMode> 1. Access 2. T&A 3. Cafeteria
		When setting to Access <F1 Time> <F2 Time> <F3 Time> <F4 Time> <Access Time> <Multi Fn-Key>
		When setting to T&A < Attend> <Leave > < Out> < In> <Access Time> <Multi Fn-Key>
	2. Verify	<Show User> <Only Card> <Use TOC> <Blocking Time> <Global Block> <NetErr TimeOut>

	3. Doorlock	<Lock Type> <Open Duration> <Open Alarm>
	4. Sound	<Voice> <Beep> <Case Open>
	5. Camera	<Use Camera>
	6. Time	<Sync Time> <Calendar> <System Time> <Time Display>
	7. RS485 Set	<RS485 ID>
	8. M.Key set	<Use M.Key> <Reg Mode> <BLE Name>
4. Terminal Info	Version	Firmware version of the terminal
	WorkMode	Terminal operating modes (T&A + security/T&A/food service)
	Language	Language setting
	Auth Mode	Authentication priority
	1:1 Level	Authentication level applied when 1:1 authentication
	1:N Level	Authentication level applied when 1:N authentication
	BLE Name	BLE module name
	BLE Ver	BLE module firmware version
	Terminal Id	Terminal ID
	Net Type	Network connection methods (Static IP/DHCP)
	Terminal IP	Terminal IP address
	Gateway	Terminal gateway address
	Subnet Mask	Terminal subnet mask address
	Server Type	Network server connection mode setting
	Server IP	IP address of the network server connected to the terminal
	Server Port	Port number of the network server program
	MAC Address	Terminal MAC address
	Card Ver	Card reader module firmware version
	Card Format	Card data display format
	All User	The total number of users registered in the terminal, including administrators
All Admin	The number of administrators registered in the terminal	
Max User	The maximum number of users who can be registered in the terminal	

	All FP	The total number of fingerprints saved in the terminal
	Max FP	The maximum number of fingerprints that can be registered in the terminal
	All Log	The number of the authentication results saved in the terminal
	Max Log	The maximum number of the authentication results that can be saved in the terminal
	Serial Num	Serial number notation
5. Ext Function	1. Lock Term	<Lock Term>
	2. Read Card	<Read Card>
	3. Monitor	<Monitor 1> <Monitor 2>
	4. Duress FP	<Duress FP>
6. Device	1. Sys Config	<ID Length> <Language>
	2. Card Format	<Card Reader> <Card Format>
	3. FP-Sensor	<1:1 Level> <1:n Level> <LFD Level> <Check FP>
	4. Wiegand	<Wiegand Out>
	5. Initialize	<Init Config> <Delete Log> <Init Terminal> <DB Backup>
	6.Ext Device	<External Device> <Local AntiPB> <Auth Mode> <Lock Ctrl>

### 3.3. User Management

Select [1.User] on the main menu, and the following screen will appear.



Press [↑][↓] buttons to select the menu you want to change, and press [ENT] button.

#### 3.3.1. Add User

Select [F3~]→[1.User]→[1.Add User] on the main screen, and the following screen will appear.



Enter the ID of the new user you wish to register, and press [F4] button long.

When registering, the available user ID is automatically displayed on the LCD so that you can register it conveniently. If necessary, you can change the ID using function keys. If other user has been already registered in the entered ID, the message of “Duplicated User ID” with “Fail” buzzer is displayed on the LCD and then the screen goes to the upper menu. If the entered ID is not registered, the following authentication type selection screen appears.

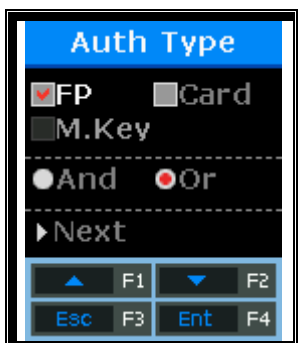

By using [↑][↓] buttons, select the authentication method and “And” or “Or”, and press “Next” button.



## 3.3.1.1. Register as “1. FP”

Register and authenticate using the fingerprint.



Default Setting: '0'

This screen is available to determine the authentication level for each user to be registered. By changing this value, the different authentication level may be set for each registered user. If this value is set to '0', the 1:1 Level set in the terminal is used instead of the user-specific authentication level.

After completion of setting, press the [ENT] button to move to the next setting.



Enter your fingerprint referring to “1.8. How to register and enter the fingerprint” as aforesaid.

When the fingerprint sensor lights on, place your finger on the fingerprint input window. When “Ppik” buzzer occurs, wait for about 2~3 seconds until the light turns off, and lift your finger. When the first fingerprint is successfully entered, the message of “Please try again” is displayed. Enter the fingerprint entered just now once again.



Enter the fingerprint entered just now once again.

It should be noted that when entering the second fingerprint after entering the first fingerprint, you must release your finger from the fingerprint input window and then enter the second fingerprint again. When the registration is completed, select “Add FP”. If it fails, the screen returns to the “1. User” screen.

The followings show LCD prompts that may appear during the registration process.

Register Success!	When registration is successful
Fail!	When registration fails
	If the fingerprint image is unclear, or if no fingerprint is entered for ten seconds after the FP sensor lights off
Duplicated FP!	If the fingerprint registered already is registered again

If registration fails even if you try to repeat 2-3 times depending on the correct fingerprint registration method, it is recommended to authenticate using the card.

3.3.1.2. Register as “2. FP”

Register and authenticate using the card only.



Place the card to register on the LCD. To cancel and exit the registration, press [ESC] button.

When the registration is completed, select “Add FP”. If it fails, the screen returns to the “1. User” menu.

The followings show LCD prompts that may appear during the registration process.

Register Success!	When registration is successful
Fail!	When registration fails
Duplicated Card!	If the card registered already is registered again

3.3.1.3. Register as “FP or Card”

The user can be registered using both card and fingerprint and then authenticated using either card or fingerprint.

The user should register his/her fingerprint (see Fingerprint Registration) and then his/her card (see Card Registration).

#### 3.3.1.4. Register with “FP and Card”

The user can be registered using card and fingerprint. Authentication is performed for the card and then for the fingerprint.

The user should register his/her fingerprint (see Fingerprint Registration) and then his/her card (see Card Registration).

#### 3.3.2. Delete User

Select [F3~]→[1.User]→[2.Delete] on the main screen, and the following screen will appear.



Enter the ID of the new user you wish to delete, and press [F4] button long.

Enter the ID of the user you want to delete from the registered users of the terminal and press [F4] button long, the successful buzzer will sound and all the information will be deleted from the terminal. However, data deletion from the terminal does not mean data deletion from the server. To delete the data permanently, it must be deleted from the server as well.

If the ID of an unregistered user is entered, the message of “Unregister” with “Fail” buzzer is displayed on the LCD and then the screen goes to the “1. User” menu.

When deleting, both general users and administrators are deleted without distinction. So you have to watch out the deletion of administrator unknowingly.

If users who are not exist in the network server but registered in the terminal are deleted, the data cannot be recovered. Therefore, special cautions are required.

### 3.3.3. Modify User

Select [F3~]→[1.User]→[3.Modify] on the main screen, and the following screen will appear.

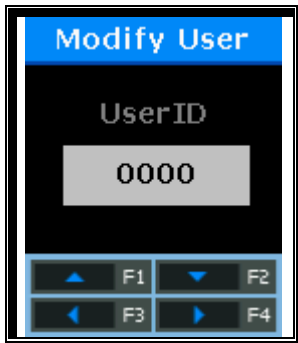

Enter the ID of the user you wish to change, and press [ENT] button long.

Both general users and administrators can be changed without distinction. If the ID of an unregistered user (or administrator) is entered, the message of “Unregister” with “Fail” buzzer is displayed on the LCD and then the screen goes to the “1. User” menu.

The changeable items of users are different according to the user authentication method and are classified as below.

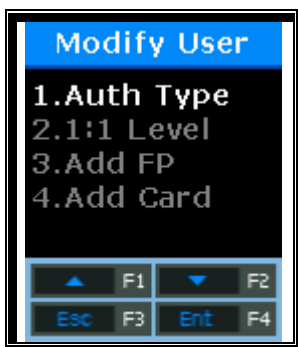

Select [1] to change the authentication method; [2] to modify the authentication level; [3] to add the fingerprint to the relevant ID; and [4] to add the card.

※Up to 10 fingerprints/cards per ID can be registered. If you try to register more than 10 fingerprints/cards, when selecting [3] or [4], “Fail” buzzer occurs and the message of “User FP/Card Full !” is displayed on the LCD.

[1] When selecting “Auth Type”

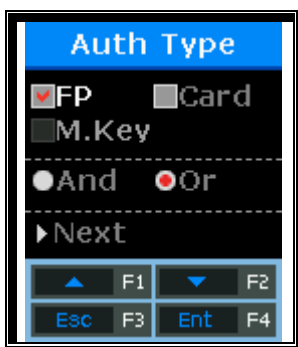

By using [↑][↓] buttons, select the authentication method and “And” or “Or”, and press “Next” button.

To modify, select the authentication methods referring to the aforementioned process of [3.3.1.1] to [3.3.1.4].

[2] When selecting “1:1 Level”

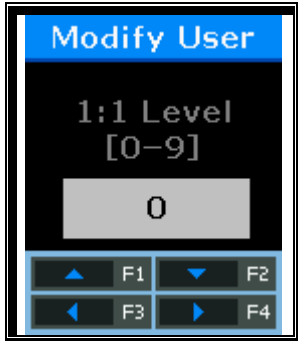

Recommended Setting: '0'

To modify, the new set value should be entered.

If this value is set to '0', the 1:1 Level set in the terminal is used instead of the user-specific authentication level.

[3] When selecting “Add FP”



Enter your fingerprint referring to “1.8. How to register and enter the fingerprint” as aforesaid.

When the fingerprint sensor lights on, place your finger on the fingerprint input window. When “Ppik” buzzer occurs, wait for about 2~3 seconds until the light turns off, and lift your finger. When the first fingerprint is successfully entered, the message of “Please try again” is displayed. Enter the fingerprint entered just now once again.



Enter the fingerprint entered just now once again.

It should be noted that when entering the second fingerprint after entering the first fingerprint,

you must release your finger from the fingerprint input window and then enter the second fingerprint again. When the registration is completed, select “Add FP”. If it fails, the screen returns to the “3. Modify” menu.

The followings show LCD prompts that may appear during the registration process.

Register Success!	When registration is successful
Fail!	When registration fails
	If the fingerprint image is unclear, or if no fingerprint is entered for ten seconds after the FP sensor lights off
Duplicated FP!	If the fingerprint registered already is registered again
User FP Full!	If ten fingerprints have been registered in the relevant ID

[4] When selecting “Add CARD”



To cancel the registration, press [ESC] button.

When placing your card on the LCD, the successful buzzer occurs and the newly entered card number is added.

If card change fails, the “Fail” buzzer occurs and the screen returns to the “3. Modify” menu.

The followings show LCD prompts that may appear during the registration process.

Register Success!	When registration is successful
Fail!	When registration fails
Duplicated Card!	If the card registered already is registered again
User Card Full!	If ten fingerprints have been registered in the relevant ID

### 3.3.4. Add Administrator

Select [F3~]→[1.User]→[4.Add Admin] on the main screen, and the following screen will appear.



Enter the ID of the administrator you wish to register, and press [F4] button long.

※ Since then, the administrator registration process is same as the general user registration process.

Only users registered as administrators have the authority to change the operating environment of the terminal, and register/modify/delete all the information of users saved in the terminal. Therefore, special attention is required for registration of terminal administrators.

### 3.3.5. Delete All Users

Select [F3~]→[1.User]→[5.Delete All] on the main screen, and the following screen will appear.

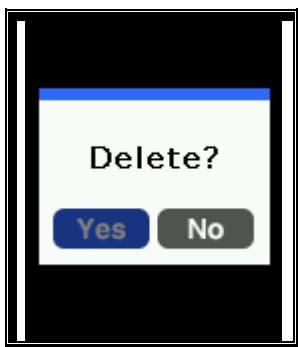

Select [1] to delete all users, and [2] to cancel.

After requesting reconfirmation, **all users including administrators are immediately deleted.** Before using this function, special attention is required.

After successful deletion, the successful buzzer occurs and then the screen returns to the “1. User” menu.

### 3.4. Network Setting

Select [2.Network] on the main menu, and the following screen will appear.

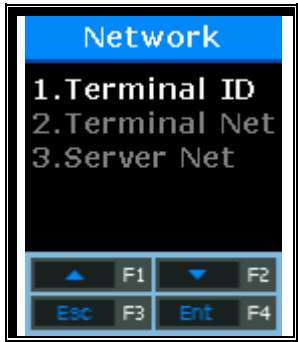

Press [↑][↓] buttons to select the menu you want to change, and press [ENT] button.

#### 3.4.1. Terminal ID

Select [F3~]→[2.Network] → [1.Terminal ID] on the main screen, and the following screen will appear.

##### 3.4.1.1. Terminal ID

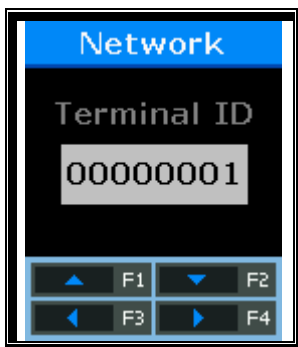

This ID is a unique ID used to allow the server to identify the terminal. The default is '00000001'.  
Default Setting: "00000001"

This ID must match the door ID set to the server program and is entered as an 8-digit number. Press [ENT] button long, and go to the next menu.

##### 3.4.1.2. Authentication Priority [NS / SN / NO / SO] Setting

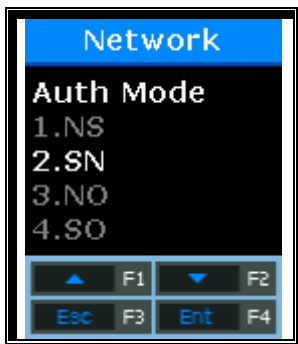

Select [1] for NS, [2] for SN, [3] for NO, and [4] for SO.  
Default Setting: '2.SN'



This menu is to determine the authentication priority between the terminal and the network, the default is '2. SN', and the authentication method in each mode operates as follows.

NS	If the terminal is connected to the server, authentication is attempted from the server. If the terminal is disconnected from the server due to a network failure, etc., authentication is attempted from the terminal.
SN	Even if the terminal is connected to the server, authentication is attempted from the terminal. The authentication result is sent to the server in real time. However, if the entered user is not registered in the terminal, authentication is attempted from the server. (If there is any fingerprint user in the terminal, the 1:N fingerprint authentication is not performed in the server.)
NO	Even if the user is registered in the terminal server, authentication is performed through the server only.
SO	Only users registered in the terminal are authenticated. If the terminal is connected to the server, the authentication result is sent to the server in real time.

The authentication priority may be set flexibly depending on the situation such as the number of terminals connected to the server, the number of authenticated users, or network failure. However, if more than 10 terminals are connected to the server and so concurrent authentication is often attempted, or if network failure often occurs, it is recommended to attempt SN authentication (set to '2').

After entering correctly, press [ENT] button, and the screen will go to the upper menu.

### 3.4.2. IP Setting

Select [F3~]→[2.Network] → [2.Terminal Net] on the main screen, and the following screen will appear.

#### 3.4.2.1. Connection Method Setting



Select [1] if Static IP is assigned, and select [2] to set IP using DHCP.

Default Setting: '1.Static'

This refers to how the terminal is connected to the network. The default is '1' (Static). Select [1] when using the Static IP assigned from the connected network, and select [2] when using the IP assigned from the DHCP server which exists in the connected network.

After entering correctly, press [ENT] button to move to the next setting.

※ If the connection method is set to 'Static IP (1)', the following procedures such as "3.4.2.2. Terminal IP Setting", "3.4.2.3. Subnet Mask Setting", and "3.4.2.4. Gateway Setting" should be set respectively. However, if the connection method is set to the dynamic IP supported by DHCP, the setting is unnecessary and so omitted.

#### 3.4.2.2. Terminal IP Setting



Press [←][→] buttons to move to the digit you want to change, and press [↑][↓] buttons to change the numbers  
Default Setting: "192.168.000.003"

Set the IP address assigned to the terminal.

After entering correctly, press [F4] button long to move to the next setting.

### 3.4.2.3. Subnet Mask Setting



Press [←][→] buttons to move to the digit you want to change, and press [↑][↓] buttons to change the numbers.  
Default Setting: “255.255.255.000”

This is to set the subnet mask of the network connected to the terminal.

After entering correctly, press [F4] button long to move to the next setting.

### 3.4.2.4. Gateway Setting

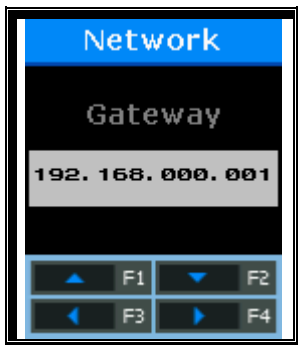

Press [←][→] buttons to move to the digit you want to change, and press [↑][↓] buttons to change the numbers.  
Default Setting: “192.168.000.001”

This is to set the gateway IP of the network connected to the terminal.

After entering correctly, press [ENT] button long, and the screen will go to the upper menu.

### 3.4.3. Server IP Setting

Select [F3~]→[2.Network] → [3.Server Net] on the main screen, and the following screen will appear.

### 3.4.3.1. Connection Method Setting

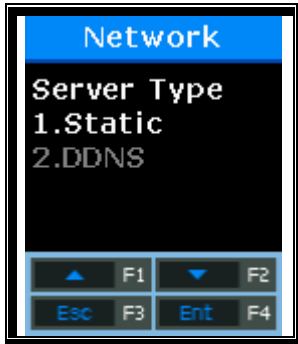

Select [1] if Static IP is assigned, and select [2] to set IP using DDNS.

Default Setting: '1.Static'

This is the way that the terminal is connected to the network.

Select [1] when using the Static IP assigned from the connected network, and select [2] when using the IP assigned from the DDNS server.

After entering correctly, press [ENT] button to move to the next setting.

- ※ If the connection method is set to 'Static IP (1)', the following procedures such as "3.4.3.2. Sever IP Setting" and "3.4.3.3. Server Port Setting" should be set respectively. However, if the connection method is set to '2. DDNS', DDNS ID needs to be additionally set and so "4.4.3.4. DDNS ID Setting" is added.

### 3.4.3.2. Sever IP Setting

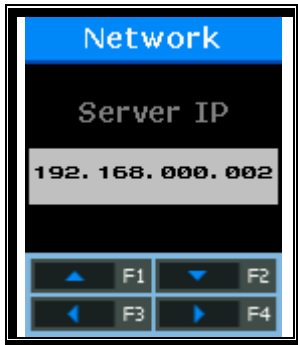

Press [←][→] buttons to move to the digit you want to change, and press [↑][↓] buttons to change the numbers.

Default Setting: "192.168.000.002"

This is to specify the IP Address of the network server connected to the terminal.

After entering correctly, press [F4] button long to move to the next setting.

### 3.4.3.3. Sever Port Setting

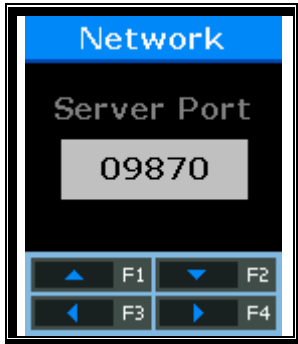

Press [←][→] buttons to move to the digit you want to change, and press [↑][↓] buttons to change the numbers.  
Default Setting: "09870"

This is to specify the Port of the network server connected to the terminal.

After entering correctly, press [F4] button long, and the screen will go to the upper menu.

### 3.4.3.4. DDNS ID Setting

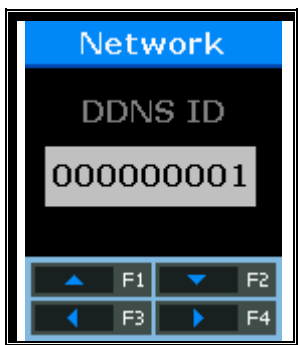

Press [←][→] buttons to move to the digit you want to change, and press [↑][↓] buttons to change the numbers.  
Default Setting: "00000001"

This appears only when the server connection method is set to "2. DDNS".

This is to specify the DDNS ID of the DDNS server connected to the terminal.

After entering correctly, press [F4] button long to move to the next setting.

### 3.4.3.5. DDNS IP Setting

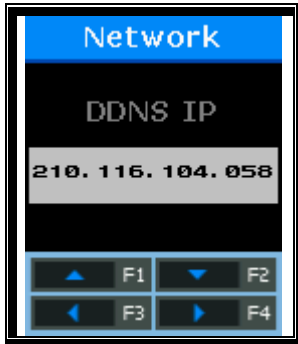

Press [←][→] buttons to move to the digit you want to change, and press [↑][↓] buttons to change the numbers.  
Default Setting: “210.116.104.058”

This is to specify the IP Address of the network server connected to the terminal.

After entering correctly, press [F4] button long to move to the next setting.

### 3.4.3.6. DDNS Port Setting

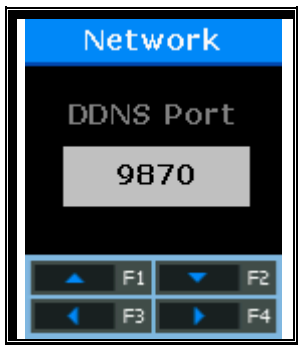

Press [←][→] buttons to move to the digit you want to change, and press [↑][↓] buttons to change the numbers.  
Default Setting: “09870”

This is to specify the Port of the network server connected to the terminal.

After entering correctly, press [F4] button long, and the screen will go to the upper menu.

### 3.5. Option Setting

Select [3.Option] on the main menu, and the following screen will appear.



Press [↑][↓] buttons to select the menu you want to change, and press [ENT] button.



#### 3.5.1. Application Setting

Select [F3~] → [3.Option] → [1. Application] on the main screen, and the following screen will appear.



Set the operating mode that you want to set.  
Default Setting: '1.Access'

This is to set an operating mode of the terminal. Select '1' for simple access control; '2' for T&A control; and '3' for Food Service management.

After selecting, press [ENT] button to move to the detail setting menu according to each operating system.

## 3.5.1.1. When setting to “[1.Access]” or “[2.T&amp;A]”

By setting the default time for each T&A mode, after authentication, the terminal display mode can be turned into the automatically set T&A mode.



If time setting is unnecessary, it is set to ‘00:00-00:00’.

This is to set the default attendance time. Press [←][→] buttons to move to the digit you want to change, and press [↑][↓] buttons to change the numbers.

Within the set time zone, the Attend mode is always displayed if another function key is not pressed. Even if the Leave mode is authenticated by pressing [F2] button, the terminal display mode is automatically turned into the Leave after authentication. Therefore, it is convenient to manage T&A.

After <F1 Time>, set <F2 Time>, <F3 Time>, <F4 Time>, and <Access Time> in the same way. As shown below, each time zone must be set not to overlap each other.

(Ex.) F1 Time=06:00~09:59, F2 Time=17:00~22:00

<F1 Time> 06:00~09:59	<F2 Time> 17:00~22:00
--------------------------	--------------------------

Subsequently, press [ENT] button, and the following screen will appear.



Default Setting: ‘2.No’

At least five authentication modes may be set if necessary. Whether to use function keys of F5~F6 is determined using F1~F3 keys. When setting to ‘1.Yes’, press the F1(F2,F3) mode once more under the F1(F2,F3) mode, and it will be changed into the F5(F6,F7) mode.



Subsequently, press [ENT] button, and the following screen will appear.

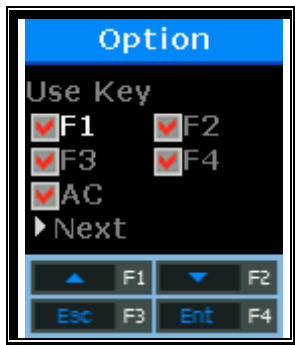

Default Setting: All 'V'

Set whether to use each function key. When setting to 'V', it means that the authentication mode may be changed when pressing the function key. When setting to Blank, the authentication mode is not changed in spite of pressing the key. When this mode is used only for Attend or Leave, it is available by unchecking other function keys.

After selecting the set value, press [ENT] button, and all authentication settings will be finished and the screen will move to the upper menu.

#### 3.5.1.2. When setting to "[3.Cafeteria]"



If time setting is unnecessary, it is set to '00:00-00:00'.

This is to set the breakfast time. Breakfast is unconditionally authenticated within the set time zone.

After setting the breakfast time, set <Lunch>, <Dinner>, <Supper>, and <Snack> in order in the same way. The unused meal time is set to '00:00-00:00'.

Each time zone must be set not to overlap each other. When the time is not set to the food time zone, the terminal displays "Locked!" message. As the terminal is locked, all inputs are blocked except for access to the menu mode.

When <Snack> is set, the menu to check whether to duplicate appears as shown below.

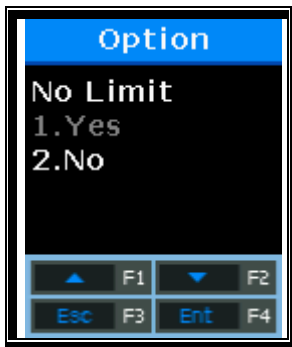

Default Setting: '2.No'

If the mode is set to 'No', authentication is once allowed within the same meal time zone. When attempting authentication again, the "Duplicated!" message is displayed and the authentication fails.

Subsequently, press [ENT] button, and the following screen will appear.



Default Setting: '2.No'

At least five authentication modes may be set if necessary. Whether to use function keys of F5~F6 is determined using F1~F3 keys. When setting to '1.Yes', press the F1(F2,F3) mode once more under the F1(F2,F3) mode, and it will be changed into the F5(F6,F7) mode.

Subsequently, press [ENT] button, and the following screen will appear.

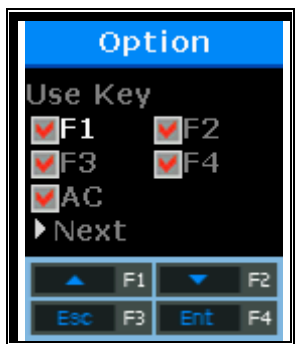

Default Setting: All 'V'

Set whether to use each function key. When setting to 'V', it means that the authentication mode may be changed when pressing the function key. When setting to Blank, the authentication mode is not changed in spite of pressing the key. When this mode is used only for Attend or Leave, it is available by unchecking other function keys.

After selecting the set value, press [ENT] button, and all authentication settings will be finished and the screen will move to the upper menu.

### 3.5.2. Authentication Method Setting

Select [F3~] → [3.Option] → [2. Verify] on the main screen, and the following screen will appear.

#### 3.5.2.1. Set whether to display ID upon successful authentication



Default Setting: '2.User Name'

- '1': displays the authenticated user ID
- '2': displays the user name on the LCD. If there is no user name, the user ID is displayed. But it marks Max 16 letters for English, Max 8 letters for Korean (Japanese/Chinese)
- '3': displays the User Key which is registered upon user registration.
- '4': displays the message entered upon user registration. But it marks Max 16 letters for English, Max 8 letters for Korean (Japanese/Chinese)

(Caution)

\* UserName and Message are set in the server. For output, the user information must be downloaded.

\* UserName and Message must be set to the same language as the terminal language.

(Example) OK!<0001>

Subsequently, press [ENT] button to move to the next setting.

## 3.5.2.2. Set whether to permit authentication using card only

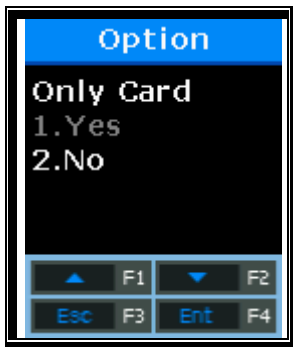

Default Setting: '2.No'

This option makes it possible to authenticate using card only without fingerprint. Even if the user is registered in FP and Card, he/she can be authenticated using card only in the terminal that this option is set to '1'.

After selecting the set value, press [ENT] button, and the screen will go to the upper menu.

## 3.5.2.3. To authenticate only using the information saved in the Smart Card

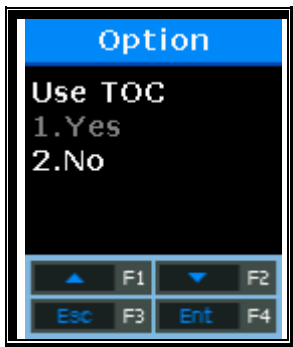

Default Setting: '2.No'

This option makes it possible to authenticate only using the user information and fingerprint recorded in the card without downloading users in the terminal. To operate this option, the terminal must be equipped with the SC card reader and it must be set to use the FP card.

After selecting the set value, press [ENT] button, and the screen will go to the upper menu.

#### 3.5.2.4. Blocking Time Setting



Default Setting: 00000 (Unit: Second)

This option is to prohibit the user from re-authenticating within the set time. There is no limit when the mode is set to '0'. However, if it is set to the greater value than '0', re-authentication cannot be permitted until the time lapses more than the set time after successful authentication.

After selecting the set value, press [ENT] button, and the screen will go to the upper menu.

#### 3.5.2.5. Global Block Setting



Default Setting: '2.No'

This option is to prohibit the user from authenticating within the short time. After successful authentication, the terminal function is blocked during the blocking time set previously.

After selecting the set value, press [ENT] button, and the screen will go to the upper menu.

## 3.5.2.6. NetErr TimeOut – Network Error Time Setting (Second)



Default Setting: '05'

In the server authentication mode, if the network error time is set, the time to wait for authentication can be set.

For example, if the error time is set to 5 seconds, when the user does not receive any response from the server for 5 seconds after authentication request, an error message comes out. (However, the user is processed as authentication failure.)

After selecting the set value, press [ENT] button, and all authentication settings will be finished and the screen will move to the upper menu.

### 3.5.3. Door Setting

Select [F3~] → [3.Option] → [3.Doorlock] on the main screen, and the following screen will appear.

#### 3.5.3.1. Lock Type Setting



Set to '1' when the terminal is connected to the strike type or automatic door, and '2' when it is connected to the motor lock.

Default Setting: '1.Strike'

Set to '1' even if the door lock is not connected.

Set to '3' if the lamp for displaying authentication success/failure is installed the lock port.

Press [ENT] button to move to the next setting.

#### 3.5.3.2. Door Open Time Setting



Default Setting: '03'(Unit: Second)

This option is to specify the time when after authentication through the terminal, the door is opened and then closed. Strike type means the time when if opening the door after authentication, the door is automatically locked again. In the case of Dead Bolt type and Auto Door, the door will work regardless of the value.

If the mode is set to '00', it is impossible to control the door. '00' must be set only when the door is not connected to Lock.

After selecting the set value, press [F4] button to move to the next setting.

### 3.5.3.3. Door Open Alarm Setting



Default Setting: '00'

This option allows the terminal to check the time when the door is open. If the door is open over the set time (minimum 5 seconds to maximum 30 seconds), an alarm occurs. When the time is set to '00', no alarm occurs. Even if the time is set to 01~04, an alarm starts to sound after the lapse of at least 5 seconds.

The door must be closed within the set time. But, it may not be closed due to unforeseen circumstances. The alarm allows users to check the cause that the door is unclosed and take any action so that the door can be closed normally.

To use this function, the lock must have the function to monitor whether the door is open or close. The monitoring pin of the lock must be also connected to the terminal. To check whether the door is open or close, the mode must be set to '2' or '3'.

After selecting the set value, press [F4] button long, and the screen will finish all the setting of the door and move to the upper menu.

### 3.5.4. Volume Setting

Select [F3~] → [3.Option] → [4.Sound] on the main screen, and the following screen will appear.

#### 3.5.4.1. Voice Volume Setting



Default Setting: '3'

This option is to set the volume during voice guidance. If the volume is set to '0', the voice message does not come out.

Press [ENT] button to move to the next setting.



## 3.5.4.2. Buzzer Volume Setting



Default Setting: '3'

This option is to set the terminal buzzer volume. The buzzer occurs silent for '0', small volume for '1', and large volume for '3'.

Press [ENT] button to move to the next setting.

## 3.5.4.3. Case Open Alarm Setting

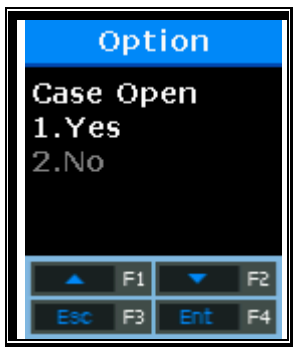

Default Setting: '1.Yes'

This option is to set whether an alarm occurs when the terminal case is open. The alarm occurs for '1' and it does not occur for '2'.

After selecting the set value, press [ENT] button, and the screen will go to the upper menu.

## 3.5.5. Camera Setting

Select [F3~] → [3.Option] → [5.Camera] on the main screen, and the following screen will appear.

## 3.5.1.1. Set whether to use camera

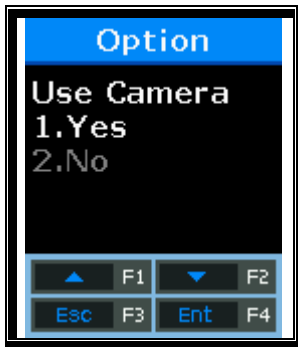

This menu is to set whether to use the camera.  
Default Setting: '1.Yes'

After selecting the set value, press [ENT] button, and the screen will go to the upper menu.

### 3.5.6. Current Time Setting

Select [F3~]→[3.User]→[6.Time] on the main screen, and the following screen will appear.

#### 3.5.6.1. Time Synchronization Setting



Default Setting: '1.Auto'

This option is to set how to synchronize the current time of the terminal with the server time. Set to '1.Auto' to automatically synchronize with server time, and set to '2.Manual' to manually synchronize with server time.

Press [ENT] button to move to the next setting.

#### 3.5.6.2. Calendar Setting



Default Setting: '1.Gregorian'

This option is to set how to display the current date in the terminal. The date is generally set to '1. Gregorian', but '2.Persian' when using the Persian calendar specially.

Press [ENT] button to move to the next setting.

### 3.5.6.3. Current Time Setting



The current time of the terminal is displayed in the order of "2009:Year, 08:Month, 01:Day, 21:Hour, 18:Min, 06:Sec". To modify, move to the desired position using [←][→] buttons, and modify the existing values using [↑][↓] buttons.

Press [ENT] button to move to the next setting.

### 3.5.6.4. Time Display Setting

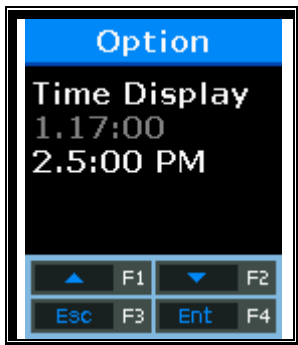

Default Setting: '2.05:00 PM'

This option is how to display the current time of the terminal. When setting to '1', the time is displayed to the 24-hour time. When setting to '2', the time is displayed by separating with AM/PM.

After selecting the set value, press [ENT] button, and the screen will go to the upper menu.

### 3.5.7. RS485 Set

Select [F3~] → [3.Option] → [7.RS485 Set] → [ENT] on the main screen, and the following screen will appear.

### 3.5.7.1. RS485 Set

This option is to set RS485 ID in order to work together with RS485 device.

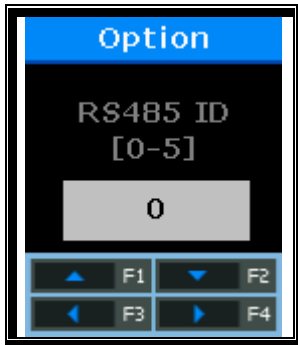

Press [↑][↓] buttons to select the ID value, and press [ENT] button.  
Default Setting: '0'

After selecting the set value, press [ENT] button, and the screen will go to the upper menu.

### 3.5.8. Mobile Key Setting

Select [F3~]→[3.Option] → [8.M.Key Set] on the main screen, and the following screen will appear.

#### 3.5.8.1. Set whether to use mobile key



Set whether to use the mobile key of the terminal.  
Default Setting: '1.Yes'

Press [ENT] button to move to the next setting.

#### 3.5.8.2. Administrator App Registration Setting



Set whether the administrator app is registered to the terminal.  
Default Setting: '2.No'

When selecting '1.Yes', the screen for interlocking with the administrator app via Bluetooth is displayed.

After interlocking with the administrator app (UNIS-B Plus), the setting and authentication mode via the terminal cannot be used. the setting mode is available in administrator app (UNIS-B Plus).

The detail setting complies with the administrator app (UNIS-B Plus) manual.

Press [ENT] button to move to the next setting.

### 3.5.8.3. Bluetooth Name Setting



When selecting '2.No' in the registration mode of 3.5.8.2, the BLE name set currently is displayed.

Press [ENT] or [ESC] button to move to the upper menu.

## 3.6. Terminal Information Inquiry

Select [3.Information] on the main menu, and the following screen will appear.



All the environmental settings of the terminal can be checked in order.

Press [↑][↓] buttons and scroll them up and down, and you can in order check the settings in the following table.

Version	Terminal firmware version
WorkMode	Terminal operating modes (T&A + security/T&A/food service)
Language	Language setting
Auth Mode	Authentication priority
1:1 Level	Authentication level applied when 1:1 authentication
1:n Level	Authentication level applied when 1:n authentication
BLE Name	BLE module name
BLE Ver	BLE module firmware version
Terminal Id	Terminal ID

Net Type	Network connection methods (Static IP/DHCP)
Terminal IP	Terminal IP address
Gateway	Terminal gateway address
Subnet Mask	Terminal subnet mask address
Server Type	Network server connection mode setting
Server IP	IP address of the network server connected to the terminal
Server Port	Port number of the network server program
MAC Addr	Terminal MAC address
Card Ver	Card reader module firmware version
Card Format	Card data display format
All User	The total number of users registered in the terminal, including administrators
All Admin	The number of administrators registered in the terminal
Max User	The maximum number of users who can be registered in the terminal
All FP	The total number of fingerprints saved in the terminal
Max FP	The maximum number of fingerprints that can be registered in the terminal
All Log	The number of the authentication results saved in the terminal
Max Log	The maximum number of the authentication results that can be saved in the terminal
Serial Num	Terminal serial number

### 3.7. Additional Function (Extra Function)

Select [5.Ext Function] on the main menu, and the following screen will appear.



Press [↑][↓] buttons to select the menu you want to change, and press [ENT] button.

#### 3.7.1. Terminal Lock Setting

Select [F3~]→[5.Ext Function]→[1.Lock Term] on the main screen, and the following screen will appear.

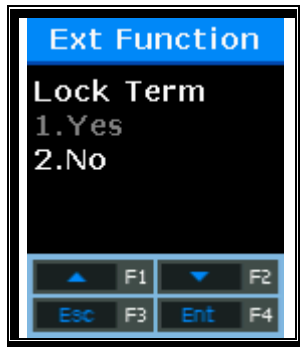

Default Setting: '2' (Unlock Terminal)

This function allows the administrator to directly lock or unlock the terminal without the server program. If it is set to '1', nobody can access the office until the administrator releases the set.

After selecting the set value, press [ENT] button, and the screen will go to the upper menu.

### 3.7.2. Card Number Inquiry

Select [F3~]→[5.Ext Function]→[2.Read Card] on the main screen, and the following screen will appear.



This is an additional function regardless of the terminal environment setting. In the case of the terminal that the card reader is added, the card number can be checked for card registration via the server. Place the card on this screen, and the card number will be displayed on the LCD.

To exit the card read, press [ESC] button to move to the upper menu.

### 3.7.3. Monitor Input Port Setting

This option acts to connect the sensor to the terminal input port, and send a notice message to the server when the status is changed.

Select [F3~]→[5.Ext Function]→[3.Monitor] on the main screen, and the following screen will appear.

(Caution) DM2 is a currently unused spare port. Before using the relevant function, check the required ports and install.

## 3.7.3.1. Monitor 1 Input Port Setting

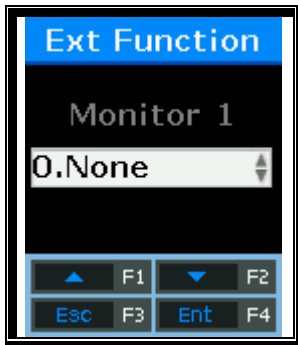

Set when connecting an external contact to DM0. (When using a motor lock, set to 1 or 2.)  
Default Setting: '0.None'

- '0.None': When nothing is connected
- '1.NO' or '2.NC': When the open door status monitoring pin is connected
- '3.Fire NO' or '4.Fire NC': When the fire detection sensor is connected
- '5.Panic NO' or '6.Panic NC': When the panic situation detection sensor is connected
- '7.EMC NO' or '8.EMC NC': When the emergency detection sensor is connected
- '9.Ctrler Out': When the authentication result is sent to the external controller  
(Connect the REDled of controller to DM0 or DM1 through the board has the TR. Set the relevant pin to '9.Ctrler Out'. WiegandOut must be set.)

Press [ENT] button to move to the next setting.

## 3.7.3.2. Monitor 2 Input Port Setting



Set when connecting an external contact to DM1. (When using a motor lock, set to 1 or 2.)  
Default Setting: '0.None'

- '0.None': When nothing is connected
- '1.NO' or '2.NC': When the open door status monitoring pin is connected
- '3.Fire NO' or '4.Fire NC': When the fire detection sensor is connected
- '5.Panic NO' or '6.Panic NC': When the panic situation detection sensor is connected
- '7.EMC NO' or '8.EMC NC': When the emergency detection sensor is connected
- '9.Ctrler Out': When the authentication result is sent to the external controller  
(Connect the REDled of controller to DM0 or DM1 through the board has the TR. Set the relevant pin to '9.Ctrler Out'. WiegandOut must be set.)

After selecting the set value, press [ENT] button, and the screen will go to the upper menu.



### 3.7.4. Duress FP Setting

Select [F3~]→[5.Ext Function]→[4.Duress FP] on the main screen, and the following screen will appear.

#### 3.7.4.1 Duress FP

This function allows users to use an alarm when the duress fingerprint is entered.



Set whether to use the duress fingerprint alarm.  
Default Setting: '2.No'

The default setting is '2.No'. When it is set to '1.Yes', if the pre-registered fingerprint is authenticated, the 'L2' Pin will output the DC12V. If any emergency detection device such as a siren is connected to this Pin, it will operate.

If <Duress FP> is set to '1.Yes', the menu for setting the time corresponding to 12V will appear.



Default Setting: '03' (Unit: Second)

To modify, Press [←][→] buttons to move to the desired position, and press [↑][↓] buttons to change the existing value.

After selecting the set value, press [ENT] button, and the screen will go to the upper menu.

### 3.8. Device Setting

Select [6.Device] on the main menu, and the following screen will appear.

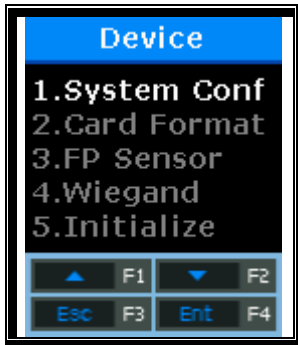

Press [↑][↓] buttons to select the menu you want to change, and press [ENT] button.



**Most of device settings are the option that does not need to change after installation. It is recommended that they are not changed unless there is any clear purpose.**

#### 3.8.1. System Configuration

Select [F3~] → [6.Device] → [1. System Conf] on the main screen, and the following screen will appear.

##### 3.8.1.1. User ID Digit Setting



Default Setting: '4'

This is a portion for setting the length of user ID. The length of user ID can be set to the 2~8 digit. It should be equal to the length of ID registered in the server program. If the 6-digit ID of '000075' is registered in the server program, the mode is set to '6'.

After setting, press [ENT] button to move to the upper menu.

### 3.8.1.2. Language Setting



Default Setting: '0.English'

If the language setting is changed, the voice message and the message on the LCD are changed into the set language.

### 3.8.2. Card Reader Format Setting

Select [F3~] → [6.Device] → [2. Card Format] on the main screen, and the following screen will appear.

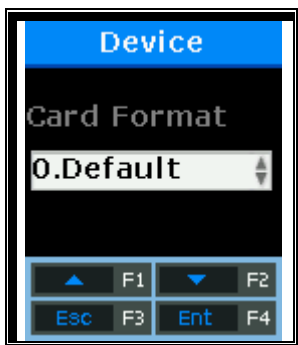

Default Setting: '0.Default'

This option is to specify the format that displays the read card number. When setting to Hexa, the format is displayed to the hexadecimal number. When setting to Decimal, the format is displayed to the decimal number. In the device equipped with the RF (low frequency) card reader, if the mode is set to '4.Format 5' and it reads EM Card, the card number is displayed to the hexadecimal number of 10byte.

### 3.8.3. Fingerprint Sensor Setting

Select [F3~] → [6.Device] → [3. FP Sensor] on the main screen, and the following screen will appear.

## 3.8.3.1. 1:1 Level Setting

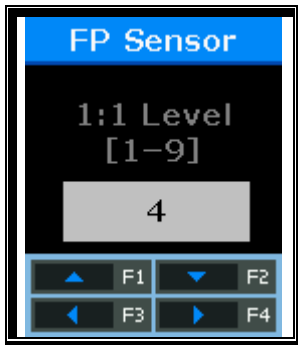

Default Setting: '4'

This option is to set the match degree with the same fingerprint when comparing the fingerprint on the fingerprint input window with the user fingerprint saved in the database. The higher authentication level may ensure the higher security. But it requires the relatively high concordance rate. When authenticating User ID, it high likely to deny authentication.

In case of 1:1 Authentication Level, if the ID entered to the authentication level that underwent the authentication process with the ID input is '1234', this option finds the fingerprint registered to the ID of '1234' from the terminal database and compares it with the fingerprint on the fingerprint input window.

However, in case of 1:1 authentication, if the 1:1 authentication level of users is not set to '0' (using the terminal authentication level), the 1:1 authentication level of users is applied.

Press [ENT] button to move to the next setting.

## 3.8.3.2. 1:N Level Setting

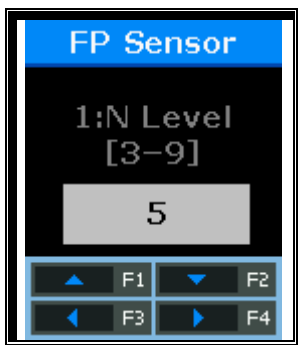

Default Setting: '4'

This option is to set the authentication level using the fingerprint only without ID input. This option is used to find the fingerprint matched by comparing the fingerprint on the fingerprint input window with the user fingerprint saved in the database.

In case of 1:N authentication, the user-specific authentication level is not set. Therefore, authentication is always based on the terminal authentication level.

Press [ENT] button to move to the next setting.

### 3.8.3.3. LFD Setting

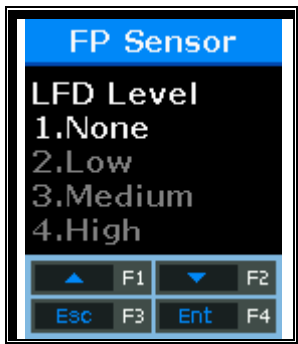

Default Setting: '1.None'

This option is to set the LFD level that can prevent fake fingerprints from entering. The higher LFD level may ensure the higher function that prevents the input of fake fingerprints made of rubber, paper, film, and silicon. However, too dry fingerprints may not be entered even when entering actual fingerprints.

After selecting the set value, press [ENT] button, and the screen will go to the upper menu.

### 3.8.3.4. Similar fingerprint registration restriction setting

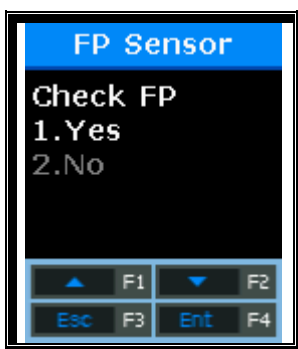

Default Setting: '1.Yes'

If the mode is set to '1.Yes', this option acts to check whether a new fingerprint is the same as the pre-registered fingerprint, and to prevent the same fingerprint from being registered as the ID of another user.

After selecting the set value, press [ENT] button, and the screen will go to the upper menu.

### 3.8.4. Wiegand Speaker Output

Select [F3~] → [6.Device] → [4.Wiegand] on the main screen, and the following screen will appear.



Default Setting: '1'

This option is used only when the terminal is equipped with a separate controller operated by Wiegand input. After authentication, the following types of data are sent to the Wiegand port of the terminal.

1.None	General case. The Wiegand Out port is not used.
2.26bit	“Sitecode [1 byte] + User ID [2 bytes]” are transferred. User ID should be set to the 4-digit or less number. Example) SiteCode:045, UID:6543 → 1 00101101 0001 1001 10001111 0
3.34bit	“Sitecode [1 byte] + User ID [3 bytes]” are transferred. User ID should be set to the 7-digit or less number. However, if User ID is 8 digits, Sitecode is ignored and only “User ID [4 bytes]” is transferred. Example) SiteCode:001, UID:123456 → 0 00000001 00000001 11100010 01000000 0
4.Custom	This is the user-defined setting that is available only in the server. Only checking is possible in the terminal.

※ This option is unrelated to use the Wiegand type card reader. If the mode is set to '2' or '3', the following site code is set.



Default Setting: '000'

This option is available only when Wiegand Out is set to '2' or '3'. The site code to send to Wiegand port including User ID is set to the value of 0~255.

After selecting the set value, press [F4] button, and the screen will go to the upper menu.

### 3.8.4.1. Bypass Setting



Default Setting: '2.No'

This option is available when the Wiegand card reader is used.

When the mode is set to [1], the card information entering to 'Wiegand In' is bypassed to 'Wiegand Out'.

### 3.8.5. Terminal Initialization

Select [F3~] → [6.Device] → [5.Initialize] on the main screen, and the following screen will appear.



Select [1] to initialize the set value; [2] to initialize the authentication records; [3] to initialize the factory; and [4] to use the UDL10 to backup the DB.

#### 3.8.5.1. Set Value Initialization



Select [1] to initialize, and [2] to cancel.

This option initializes all settings of the terminal except for the MAC (physical) addresses and serial numbers saved in the terminal. But, users and authentication records are not deleted.

When initialization is successfully completed, the "Ppiririck" beep occurs and the screen moves to the upper menu.

### 3.8.5.2. Authentication Records Initialization



Select [1] to initialize, and [2] to cancel.

This option deletes all authentication related logs except for set values and users. When initialization is successfully completed, the “Ppiririck” beep occurs and the screen moves to the upper menu.

### 3.8.5.3. Factory Initialization



Select [1] to initialize, and [2] to cancel.

This option deletes all settings, users and log information except for the MAC (physical) addresses and serial numbers saved in the terminal, and initializes the terminal to the status shipped at a factory.

When initialization is successfully completed, the success buzzer occurs and then the terminal is rebooted.

### 3.8.5.4. UDL(USB Data Logger) Backup

- If the UDL10 has the USB memory card is inserted, the mode moves to the sub-menu. If USB is not inserted, the warning message of ‘Not Detected Memory’ is displayed.



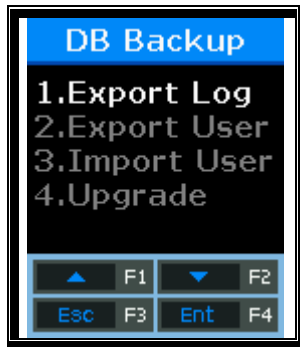

DB Backup Menu.

- ✓ Export Log
  - Used when the log data saved in the AC2200 terminal is exported to USB.
  - Data is saved with a file name of LOG.DAT in the place of “USB top-level folder → AC2200 folder → 00000000 (8-digit terminal ID) folder → LOG folder”.
  - Only log data can be saved, except for photos.
- ✓ Export User
  - Used when the user data saved in the AC2200 terminal is exported to USB.
  - Data is saved with a file name of USER.DAT in the unisuser folder.
  - The number of exported users can be checked on the LCD.
- ✓ Import User
  - Used when the user data (USER.DAT) saved in USB is imported into the terminal.
  - The user file (USER.DAT) must be saved with a file name of USER.DAT in the unisuser folder.
  - The size of imported data can be checked on the LCD.
- ✓ Upgrade
  - Used when upgrading the terminal firmware by using the firmware data (ac2200.bin) saved in the USB.
  - The firmware file is ‘ac2200.bin’. To upgrade, it must be saved with a file name of ac2200.bin in the AC2200 folder.
  - The size of imported data can be checked on the LCD.

**Caution!!**

When removing the USB or powering off the terminal during upgrading, the product may not work properly. Special caution is required.

## 3.8.6. External Device Setting

Select [F3~] → [6.Device] → [6.Ext Device] on the main screen, and the following screen will appear.



Default Setting: '1.None'

This option is available when connecting the Slave Reader using the card or fingerprint to the terminal in order to use as a secondary authentication device. The mode is set to '2' when connecting the Wiegand card reader, and '3' when connecting the SR100.

Press [ENT] button to move to the next setting.



Default Setting: '2.No'

When setting to '1.Yes', the Anti-Passback in the terminal is checked.

This screen is displayed only when <Ext Device> is set to '2' or '3'.

This option is used to allow only authorized users to access and leave the office. To this end, the terminal and Slave Reader are installed to both the inside and outside of the door. Only users who access the office by authentication via the terminal can leave the office by authentication via the Slave Reader. When setting '1.Yes', the server authentication is unavailable. The device checks whether Passback is valid in the authentication order between the terminal and the Slave Reader.

Press [ENT] button to move to the next setting.



Default Setting: '0'

This option is to set the authentication (T&A) mode saved from the Slave Reader. If the device is set to '0', it is saved as the current authentication mode; saved to F1 when '1', F2 when '2', Access when '3', F3 when '4', and F4 when '5'.

Press [ENT] button to move to the next setting.



Default Setting: '1.None'

This screen is displayed only when <Ext Device> is not set to '3'.  
When connecting an external device of LC010 to the terminal, the mode is set to '2.Lock Ctrl'.  
When the terminal interlocks with MCP040, RS485 ID must be set.

## 4. How to Use Terminal

### 4.1. When operating to [1.Access]

- Set to Menu → 3.Option → 1. Application → [1.Access].

#### 4.1.1. Authentication Mode

- Press function keys, change to the desired authentication mode such as F1, F2, F3, F4, and then perform authentication. When perform authentication without pressing function keys specially, the mode is automatically authenticated to the access mode.
- Authentication Method
  - F1 Authentication: Press [F1] key to change to the F1 mode, and then perform authentication. Authentication is performed without changing the mode within the time zone set to the Attend time.
  - F2 Authentication: Press [F2] key to change to the F2 mode, and then perform authentication. Authentication is performed without changing the mode within the time zone set to the Leave time.
  - F3 Authentication: Press [F3] key to change to the F3 mode, and then perform authentication.
  - F4 Authentication: Press [F4] key to change to the F4 mode, and then perform authentication.
  - Access Authentication:
    - Press twice [F4] key or press [F4] key long to change to the access mode, and then perform authentication. Or, perform authentication without changing the mode within the time zone set to the access time.

#### 4.1.2. Authentication Using Fingerprint

After changing the authentication mode by pressing function keys, place your finger on the fingerprint sensor. Then, the authentication result receiving the fingerprint will appear on the LCD with a voice message.

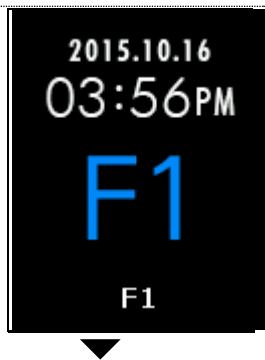

At the alert status, press [F1] key to change the authentication mode to 'F1'.



Place your finger on the fingerprint sensor, and the white light is on the fingerprint input window. Keep your finger until the white light is off with a beep sound.



If your fingerprint is successfully authenticated, the voice message of "You are authorized" comes out and a success message is displayed on the LCD.

※Error Message: The following messages will appear with the voice message of "Place try again".



When authentication fails



When the fingerprint is registered but its authentication is attempted out of the access control time

#### 4.1.3. Authentication Using Card

- ▶ For users who have registered to [Card] or [FP or Card], place the card on the main screen, and the beep sound will occur and the authentication result will displayed on the LCD.

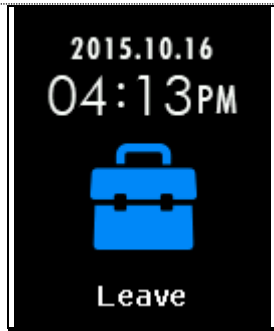

Press [F2] key to change the authentication mode to Leave.



If your fingerprint is successfully authenticated, the voice message of “You are authorized” comes out and a success message is displayed on the LCD.

Error Message: The following messages will appear with the voice message of “Please try again”.



When a unregistered card is entered



When the card is registered but its authentication is attempted out of the access control time

- ▶ For users who are registered with the [FP and Card]  
Place the card on the main screen, and the “beep” sound occurs. The fingerprint cannot be authorized without going through the following fingerprint input process.



When the lamp is on the fingerprint input window with the voice message of “Please enter your fingerprint”, enter your fingerprint and keep your finger until the “beep” sound occurs.

#### 4.2. When operating to [2.T&A]

- Set to Menu → 3.Option → 1. Application → [2.T&A].
- If you set <Attend> and <Leave > under the condition that the attend time is constant, even if authentication is attempted without pressing [F1] or [F2] keys, the fingerprint is authenticated to ‘Attend’ within the time zone set to ‘Attend’ and to ‘Leave’ within the time zone set to ‘Leave’. Therefore, users can reduce the T&A input error.

##### 4.2.1. Authentication Mode

- Press function keys to change the authentication mode to Attend, Leave, Outdoor, Return, and Access, and then perform authentication with each authentication mode.
- Authentication Method
  - Attend Authentication: Press [F1] key to change to the attend mode, and then perform authentication. Authentication is performed without changing the mode within the time zone set to the Attend time.
  - Leave Authentication: Press [F2] key to change to the leave mode, and then perform authentication. Authentication is performed without changing the mode within the time zone set to the Leave time.
  - Outdoor Authentication: Press [F3] key to change to the outdoor mode, and then perform authentication.
  - Return Authentication: Press [F4] key to change to the return mode, and then perform authentication.
  - Access Authentication: Press twice [F4] key or press [F4] key long to change to the access mode, and then perform authentication. Or, perform authentication without changing the mode within the time zone set to the access time.

##### 4.2.2. Fingerprint Authentication

- Press the function key to change the T&A mode.
- Enter your fingerprint.

##### 4.2.3. Authentication Using Card

- Press the function key to change the T&A mode.
- Place the card on the terminal.

#### 4.3. When operating to [2.Cafeteria]

- Set to Menu → 3.Option → 1. Application → [3.Cafeteria].

- When the mode is set to the food service control, the terminal is locked in the time other than meal times. The meal time must be set to more than one meal per person.
- LCD

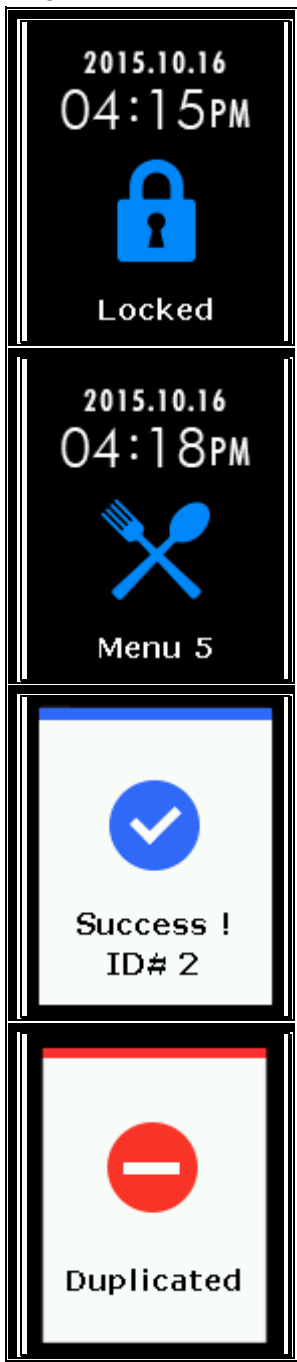

When it is not the meal time (No authentication attempt)

The default screen during the meal time

If the authentication is successful

When the mode is set to “Not-allowed Duplicate Authentication Unallowable”, if the authentication is again attempted after successful authentication, a duplicate authentication error is displayed.

- When authenticating with the fingerprint  
Enter the fingerprint to receive authentication.
- When authenticating with the card  
Enter the card to receive authentication.
- When attempting authentication without pressing the menu key, it is automatically authenticated to [Menu 1].